



Supreme 100
Supreme 150/Performer 150
Supreme 250/Performer 250
Supreme LCD

Instructions for use





Das Symbol  auf dem Produkt bzw. auf der Produktverpackung deutet an, dass das Produkt nicht mit dem Haushaltsmüll entsorgt werden darf. Stattdessen ist es zur Entsorgung an eine geeignete Sammelstelle für das Recycling von elektrischen und elektronischen Geräten zu bringen. Durch die korrekte Entsorgung helfen Sie mit, potenziellen negativen Einflüssen auf die Umwelt und die Gesundheit vorzubeugen, die durch eine unangemessene Entsorgung dieses Produktes entstehen könnten. Genauere Informationen zur Wiederverwertung dieses Produktes erhalten Sie von Ihrer Stadtverwaltung, der Müllabfuhr vor Ort oder dem Geschäft, in dem Sie dieses Produkt erworben haben.



Symbolen  på produkten eller emballaget anger att produkten inte får hanteras som hushållsavfall. Den skall i stället lämnas in på uppsamlingsplats för återvinning av el- och elektronikkomponenter. Genom att säkerställa att produkten hanteras på rätt sätt bidrar du till att förebygga eventuellt negativa miljö- och hälsoeffekter som kan uppstå om produkten kasseras som vanligt avfall. För ytterligare upplysningar om återvinning bör du kontakta lokala myndigheter, sophämtningstjänst eller affären där du köpte varan.



The symbol  on the product or on its packing indicates that this product may not be treated as household waste. Instead it shall be handed over to the applicable collection point for the recycling of electrical and electronic equipment. By ensuring this product is disposed of correctly, you will help prevent potential negative consequences for the environment and human health, which could otherwise be caused by inappropriate waste handling of this product. For more detailed information about recycling of this product, please contact your local city office, your household waste disposal service or the shop where you purchased the product.



Tämä merkki  tuotteessa tai pakkauksessa osoittaa, ettei tuotetta saa käsitellä kotitalousjätteenä. Se on sen sijaan toimitettava asianmukaiseen sähkö- ja elektroniikkakomponenteille tarkoitettuun keräyspisteeseen. Kun varmistat, että tuotetta käsitellään oikealla tavalla, autat ehkäisemään ympäristö- ja terveyshaittoja. Niitä saattaa syntyä, mikäli tuote hävitetään tavallisen jätteen mukana. Lisätietoja kierrätyksestä saat ottamalla yhteyttä paikallisiin viranomaisiin, jätteenkeräyspalveluun tai myyntipisteeseen, josta tuote on ostettu.



Symbolet  som findes på produktet eller emballagen, viser, at produktet ikke må bortskaffes sammen med almindeligt husholdningsaffald. Det skal derimod afleveres på en miljøstation, som er godkendt til håndtering af elektrisk og elektronisk udstyr. Sørg for at bortskaffe produktet korrekt, så du kan være med til at forebygge skader på miljøet og menneskers sundhed. Hvis du ønsker yderligere oplysninger om, hvordan produktet genvindes, kan du henvende dig hos kommunen, en miljøstation eller forretningen, hvor du købte produktet.

DE	BEDIENUNGSANLEITUNG	3 - 19
SV	BRUKSANVISNING	20 - 34
EN	INSTRUCTIONS FOR USE	35 - 50
FI	KÄYTTÖOHJE	51 - 65
DA	BRUGSANVISNING	66 - 80

Contents

1. Important safety precautions	36
1.1 Technical data.....	36
1.2 Essential instructions (UK only).....	36
2. Vacuum unit Supreme 100 assembly instructions	38
2.1 Fitting the wall bracket.....	38
2.2 Locating the vacuum cleaner on the wall bracket.....	38
2.3 Connecting the machine	38
3. Operating instructions Supreme 100	39
3.1 Starting the machine	39
3.2 Servicing	39
4. Filter and dust bags - Supreme 100	40
4.1 Replacing the dust bag	40
4.2 Replacing / cleaning the filter	40
5. Vacuum unit Supreme 150 / Performer 150 / Supreme 250 / Performer 250 / Supreme LCD assembly instructions	41
5.1 Fitting the wall bracket	41
5.2 Locating the vacuum cleaner on the wall bracket	41
5.3 Connecting the machine	41
5.4 Utility inlet (standard accessory in Canada)	42
6. Operating instructions Supreme 150 / Performer 150 / Supreme 250 / Performer 250 / Supreme LCD	42
6.1 Starting the machine	42
6.2 Servicing	42
6.3 Supreme LCD Display	42
7. Filter and dust bags - Supreme 150 / Performer 150 / Supreme 250 / Performer 250 / Supreme LCD	44
7.1 Replacing the bag filter	44
7.2 Fitting the bag filter	44
7.3 Replacing the dust bag	44
7.4 Fitting the dust bag	44
8. Electrical connection	45
9. Accessories	46
10. Troubleshooting	47
10.1 Service/maintenance guide - Supreme 100	47
10.2 Service/maintenance guide - Supreme 150 / Performer 150 / Supreme 250 / Performer 250 / Supreme LCD	48
11. Dimensional drawings	49
12. Wireless communication - Wireless+/Deluxe	50
Declaration of Conformity	82

Congratulations on your choice of central vacuum cleaner! If you use your vacuum cleaner in accordance with these operating instructions, your machine will be a pleasure to use and an essential worktool in your home for many years to come.

*Our products are under constant development and we, therefore, reserve the right to make any necessary alterations to the design of the machine.
We also make reservations concerning any misprints that may arise.*

Legislation governing consumer compensation claims apply to this product under current terms of sale - on the assumption that the product has been used correctly (for household use) and maintained in accordance with the instructions contained in this user guide. Dust bags are consumables.

This product comes under the various countries' statutory requirements concerning the collection and safe treatment of electrical products and, when the time comes for its disposal, it should be handed over to a dealer or waste disposal site for recycling purposes.

Complaints caused by faulty or incorrect assembly should be made to the installation firm responsible. Entitlement to compensation may not apply through failure to use the machine correctly or gross negligence concerning the maintenance of the product.

1 Important safety precautions

To reduce the risk of fire, electric shock or injury, read all safety precautions and warning text carefully before using the machine.

- This central vacuum cleaner is solely intended for dry vacuuming indoors.
- This central vacuum cleaner is not intended to be installed outdoors.
- Never vacuum without a filter installed.
- Do not vacuum up liquids. Do not use the machine in wet surroundings.
- Do not vacuum up embers or burning objects such as cigarettes, matchsticks, hot ash or flammable liquid or gas.
- Do not vacuum in areas where flammable liquids or gases may be present.
- Unplug the machine before changing the filter or bag and before doing any maintenance work.
- Always unplug the machine by pulling on the plug, not the power cord.
- The wall socket and plug must be positioned so that they are clearly visible.
- Do not vacuum up sharp objects such as broken glass or needles that could puncture the bag and damage the motor.
- Be particularly careful not to pick up objects that could block the hose/pipe system, such as pencils, toy bricks and small plastic bags.
- Follow the operating instructions carefully. Servicing and repairs should only be carried out by an authorised workshop. Use only original parts and accessories as recommended by the supplier. Never attempt to modify the machine yourself.
- Do not use the central vacuum cleaner if the power cord is damaged. The central vacuum cleaner is fitted with a special type of power cord that must be replaced with a cord of the same type if it is damaged. A power cord of this type can be obtained from a service contact. To avoid any risk, this power cord should be replaced by a qualified expert.
- This appliance is not intended for use by young persons or infirm persons without supervision unless they have been adequately supervised by a responsible person to ensure that they can use the appliance safely.
- The central vacuum cleaner must not be used as a toy.
- The installation of the exhaust pipes must be done, so that no water or condensation will get into the installation system.

The central vacuum cleaner must never be used to vacuum up contaminated dust or cement dust.

1.1 Technical data

Technical data, machine	Supreme 100	Supreme 150 Performer 150	Supreme 250 Performer 250	Supreme LCD
Height	427 mm	800 mm	801 mm	802 mm
Width with handles	370 mm	370 mm	370 mm	370 mm
Length with bracket	400 mm	400 mm	400 mm	400 mm
Motor	1300 W	1550 W	1700 W	1700 W
Fuse	10 A	10 A	10 A	10 A
Weight	5 kg	6.5 kg	6.5 kg	6.5 kg
Sound output	66 dB	66 dB	66 dB	66 dB
Capacity of dust container	-	25 l	25 l	25 l
Capacity when using the bag	10 l	14 l	14 l	14 l
Max suction power motor	650 Airwatt	720 Airwatt	735 Airwatt	735 Airwatt
Max suction power*	460 W	490 W	510 W	510 W
Max air flow*	50 l/s	53 l/s	54 l/s	54 l/s
Max vacuum*	21 kPa	30 kPa	30 kPa	30 kPa
Radio remote control	X	X	X	X
Panel with operation status				X

Technical data, handle	LED	LCD
Radio frequency	433 MHz	
Function	On/off, power regulation 5 steps, LED indication of operation status	On/off, power regulation 5 steps, LCD indication of operation status
Lifetime of battery	3 years	
Battery type, qty.	1.5 V AAA, 2 pcs	
Range of operation	Max 50 metres.	

*Measured on the suction unit

These appliances conform with EU Instructions 2004/108/EC, 2006/95/EC.

PLEASE READ THESE ESSENTIAL INSTRUCTIONS (Only applicable to UK)

These Central Vacuum Cleaners are designed, developed and rigorously tested to function efficiently and safely when properly maintained and used in accordance with the following instructions. These instructions have been prepared for your safety and must be followed.

CAUTION - This machine **MUST NOT** be used in explosive or inflammable atmospheres or where such atmospheres are likely to be produced by the presence of volatile liquid or inflammable gas or vapour.

CAUTION - In no circumstances should the power supply cord be wrapped around fingers or any part of the operators person.

CAUTION - The electrical supply plug must not be subjected to undue stress by pulling on the power supply cord.

CAUTION - This Central vacuum cleaner is to be placed in dry areas only, the machine should not be placed in areas where the temperature goes higher than 40° C.

Your machine must only be connected to an electrical supply of the same voltage and frequency indicated on the rating plate. Ensure that the plug fitted to the end of the power supply cord is suitable for your supply socket. If not, consult a qualified electrician. The electrical installation from which the supply is drawn must be maintained to current Institute of Electrical Engineers wiring regulations.

REGULAR SERVICING AND INSPECTION of your machine must be carried out by suitable qualified personnel in accordance with relevant legislation and regulations. In particular, electrical tests for earth continuity, insulation resistance and condition of the flexible cord should be checked frequently. In the event of any defect the machine **MUST** be withdrawn from service, completely checked and repaired. Trained Service Engineers will be pleased to carry out on site servicing on a regular or as requested basis, to ensure the continuing safety and efficiency of your machine.

ELECTRICAL CONNECTION

(Only applicable to U.K)

DOUBLE-INSULATED MACHINES IMPORTANT

240 volt 50 Hz. machines are fitted with a 13 amp. 3 pin moulded plug. A replacement fuse must be in accordance to BS 1362, Asta approved and have a value of 13 amp.

- Important:**
- The fuse cover must be refitted after changing the fuse.
 - In the event of the fuse cover being misplaced, the plug must not be used until the fuse cover is replaced.
 - Ensure that the replacement fuse cover is the same color as the insert or, as the colour embossed in words on the base of the plug.
 - For replacement fuse covers please contact your local electrical store.

If the available socket outlet is not suitable for the plug supplied, the plug must be cut off and an appropriate plug fitted. The plug that is cut off **MUST BE DESTROYED** for safety reasons before being disposed of. Machines built for other voltages and frequencies are not normally supplied with a fitted plug. If it is necessary to fit a plug, the wires in this power supply cord are coloured in accordance with the following code:

**BLUE-NEUTRAL
BROWN-LIVE**

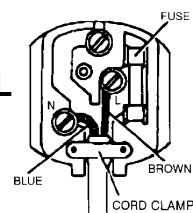

To connect the new plug:

If using a three-pin plug, do not make any connection to the terminal in the plug which is marked with the letter 'E' or by the safety earth symbol or coloured green or green and yellow. This machine is double-insulated and no earth connection is necessary. The wire which is coloured blue must be connected to the terminal in the plug which is marked with the letter 'N' or is coloured black or blue. The wire which is coloured brown must be connected to the terminal in the plug which is marked with the letter 'L' or is coloured red or brown. If the plug to be fitted does not conform to the above notation then consult a qualified electrician.

This appliance conforms with EC-Instructions 2004/108/EC, 2006/95/EC.

2 Vacuum unit Supreme 100 assembly instructions

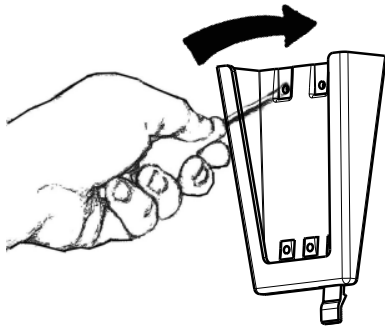

Fig. 1

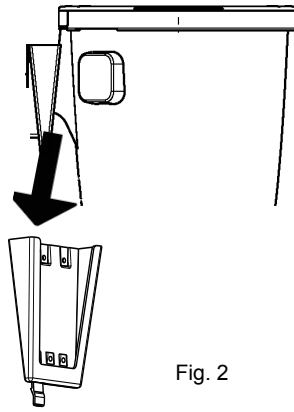
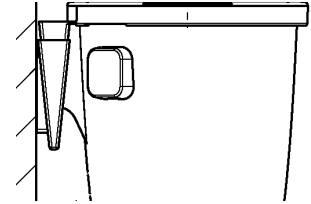

Fig. 2



2.1 Fitting the wall bracket

Position the holder so that there is plenty of space above and below the place where the vacuum unit is to be located. Make sure there is a minimum of 500 mm free space above the container. Mark the positions for the four screw holes with a pen or similar. Then select appropriate screws and, if necessary, wall plugs for the type of wall surface to which the bracket is to be attached. Drill the four holes for the wall bracket. The diameter of the screw holes in the holder is 5 mm. Fit the wall bracket with the large opening pointing upwards, see Fig. 1. Tighten the screws so that the holder is held firmly in place (screws provided).

2.2 Locating the vacuum cleaner on the wall bracket

Position the vacuum unit so that the wall bracket is directly above the vacuum unit, see Fig. 2. Lower the machine down on to the wall bracket. Make sure the corresponding bracket on the machine is held firmly in place by the wall bracket.

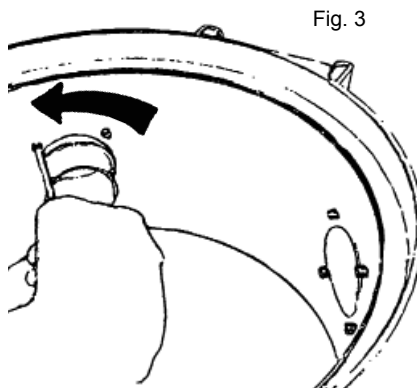

Fig. 3

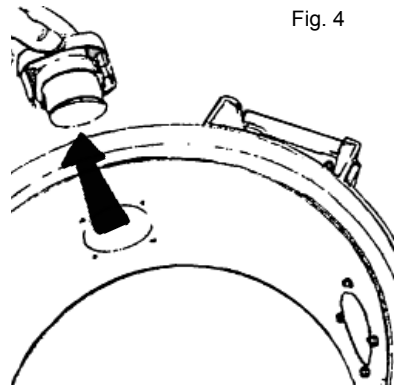

Fig. 4

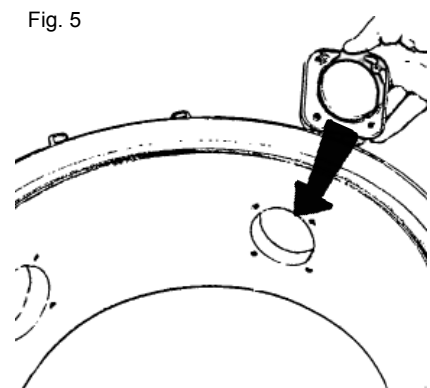

Fig. 5

2.3 Connecting the machine

The machine is connected with the suction pipe in the uppermost position and the exhaust pipe in the lower position.

This connection should not be glued but can be taped when the unit is serviced at a later date. The suction pipe socket can be fitted to two different points depending on the direction in which you would like to install the pipe system.

To relocate the suction pipe socket, you need to do the following:

1. Release the suction pipe socket by unscrewing the four combination Torx screws with a Torx T20 or an ordinary screwdriver, Fig. 3.
2. Pull the socket out of the machine, see Fig. 4.
3. Loosen the plug blanking off the outlet to which you intend moving the suction pipe socket. Unscrew the four combination Torx screws. Remove the blanking plug from the machine.
4. Adapt (move) the suction pipe socket to the new outlet. NB! The socket is marked "Up". Make sure the socket is fitted with "Up" uppermost. Fasten the socket by fitting and tightening the four screws, Fig. 5.
5. Fit the blanking plug to the outlet previously occupied by the suction pipe socket. Use the four screws to hold it in place. The exhaust pipe must be firmly attached to the wall to ensure its connection with the socket does not loosen. Remember that you will need to be able to turn the bent pipe in different directions to ensure a suitable pipe layout. Then connect up the exhaust pipe and muffler, Fig. 6. Fit the central vacuum cleaner so that the exhaust pipe is as short as possible, max. 5 metres. Take the surroundings into consideration when positioning the exhaust. For this reason, you should always fit a muffler.

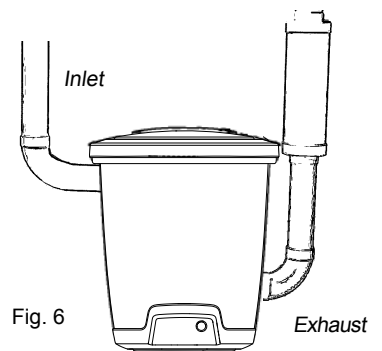

Fig. 6

For additional information concerning the assembly and installation of the pipe system and low-current lead, please refer to the separate assembly instructions supplied with the pipe package.

3 Operating instructions Supreme 100

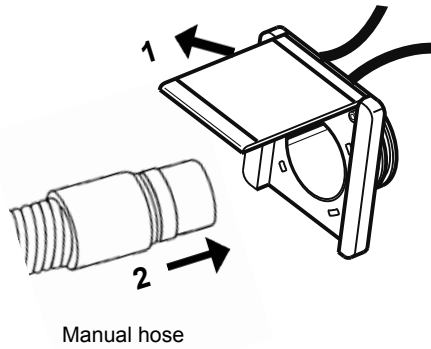

Fig. 7

3.1 Starting the machine

The control current outlet (low voltage) should be connected to a control current lead running the length of the pipes. Both ends of the low-voltage lead should be connected to the connection panel on the vacuum cleaner. One lead to each outlet.

The central vacuum cleaner's power cable must be connected to a 230 volt mains socket. The appliance is double-insulated and does not need to be earthed.

Start/stop button

All models have a start/stop button on the front to start and stop the power unit, Fig. 8. The start/stop button can also be used when/if you want to use a Nilfisk utility inlet to vacuum direct from the machine (if you do not have a Nilfisk hose with remote control) or for testing and demos.

Fig. 8

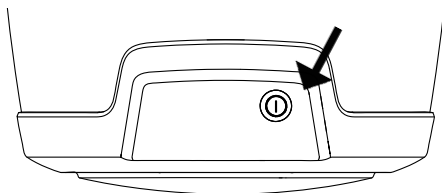

Manual hose

The vacuum cleaner starts and stops automatically. When the vacuum hose is connected to a vacuum socket, a metal ring on the end of the hose closes the control circuit and the vacuum cleaner starts up. Fig. 7. When the hose is removed from the vacuum socket, the vacuum cleaner stops.

Wireless handle

If you use a hose with a wireless handle, you can start and stop the vacuum cleaner using the switch on the handle, Fig. 9. Wireless handles also have the feature of adjusting the suction power of the cleaner, using the buttons at the hose handle.

Fig. 9

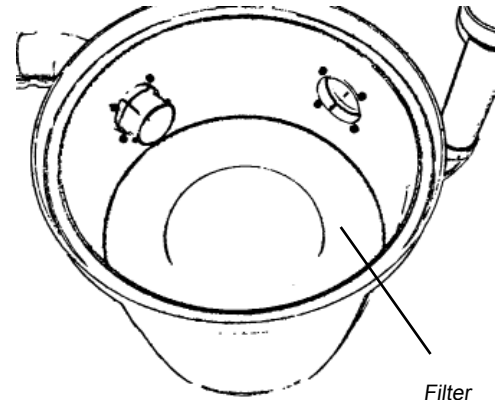
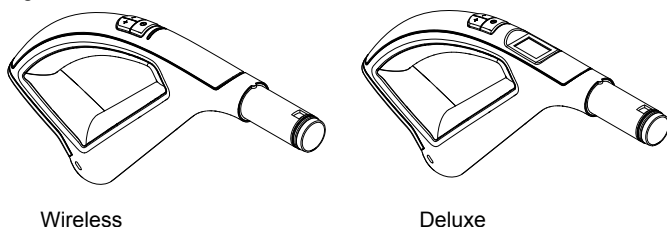

Fig. 10

3.2 Servicing

Always unplug the power cord before doing any service work!

If suction is poor, it indicates that the flow of air through the machine is restricted. This may be due to the following:

- The dust bag is full and should be replaced.
- The filter is clogged and should be cleaned.

The vacuum cleaner has a thermal cut-out that trips if the vacuum cleaner becomes overheated. If this happens - unplug the main power cord to reset the vacuum cleaner. Wait 5-10 minutes to allow the machine to cool down. While you are waiting, check the hose, dust bag and filter to be sure that nothing is blocking the flow of air through the machine. The vacuum cleaner should now start again. If the cut-out trips again, you need to get a service firm to remedy the fault.

The model Supreme 100 should only be operated with a dust bag and filter installed.

4 Filter and dust bags - Supreme 100

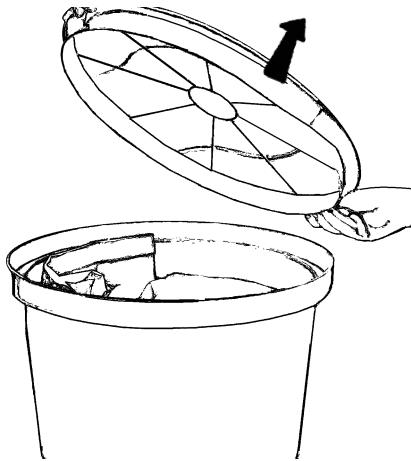

Fig. 11

4.1 Replacing the dust bag

The central vacuum cleaner is fitted with a dust bag as standard; **never vacuum without a dust bag installed.**

Grasp the edge of the lid and pull upwards to open it, Fig. 11.

Replacing the dust bag: Remove the old dust bag by turning the cardboard stiffener to the right or left so that the raised part of the inlet is in line with the opening in the card. Now slide the bag off the bag nozzle.

Fit the new dust bag as follows: Push the opening in the cardboard over the elevation on the inlet and pull on the new bag. Turn the cardboard to lock the bag in place. NB! Turn the edges of the dust bag down into the container. This is to avoid damaging the bag with the lid.

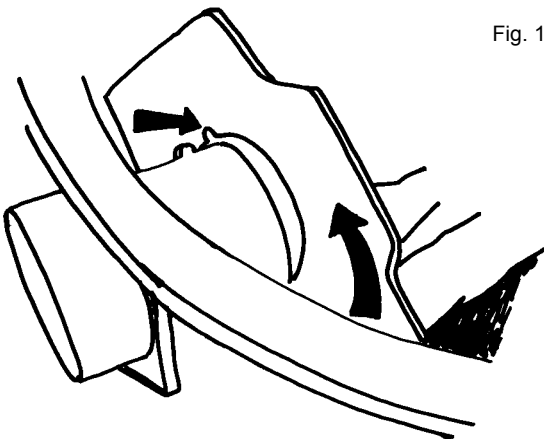

Fig. 12

The cardboard stiffener locks the bag in place when you twist it as shown in Fig. 12 above.

The opening in the card must line up and slide over the elevation on the inlet before you twist the cardboard stiffener to lock it.

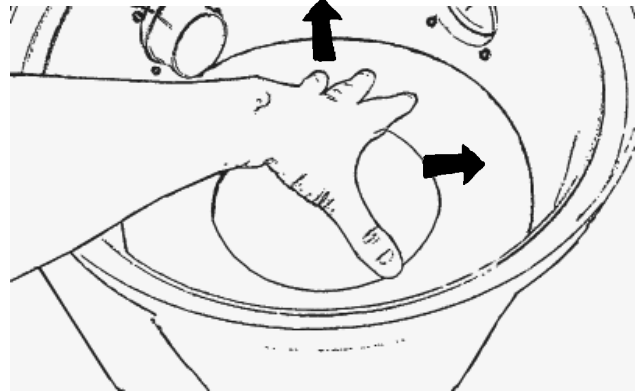

Fig. 13

4.2 Replacing / cleaning the filter

Open the lid and take out the dust bag as described earlier. The filter sits at the bottom of the container around the motor housing. **Never use the central vacuum cleaner without a filter installed.**

Pull the filter out of the container, Fig. 13. The filter can be cleaned by shaking it or washing it in water.

If you wash the filter, you must let it dry completely before refitting it.

Take the cleaned/new filter and place it in the bottom of the container. Press the outer edge of the filter down against the sides of the container. Then push the filter down into place. Make sure the filter is packed in tightly against the motor housing, Fig. 14. Reinstall the dust bag and replace the lid. Check that the lid is firmly secured.

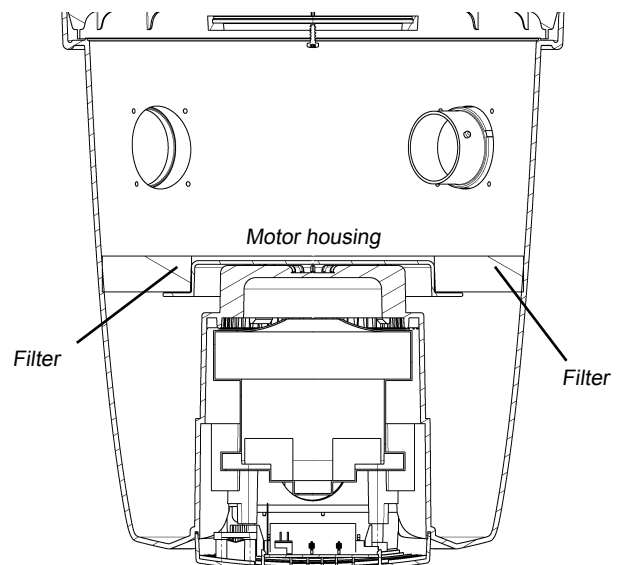

Fig. 14

5 Vacuum unit Supreme 150 / Performer 150 / Supreme 250 / Performer 250 / Supreme LCD assembly instructions

Fig. 15

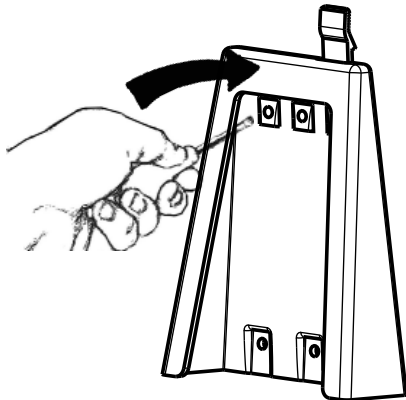

Fig. 16

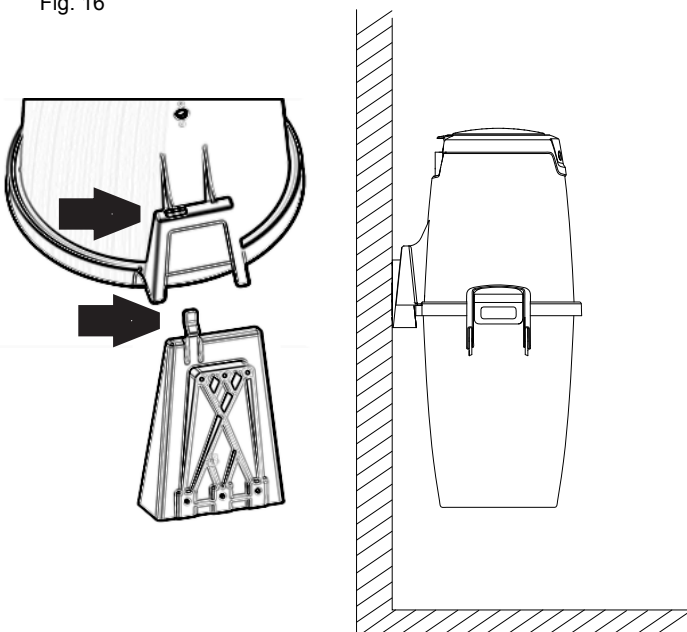
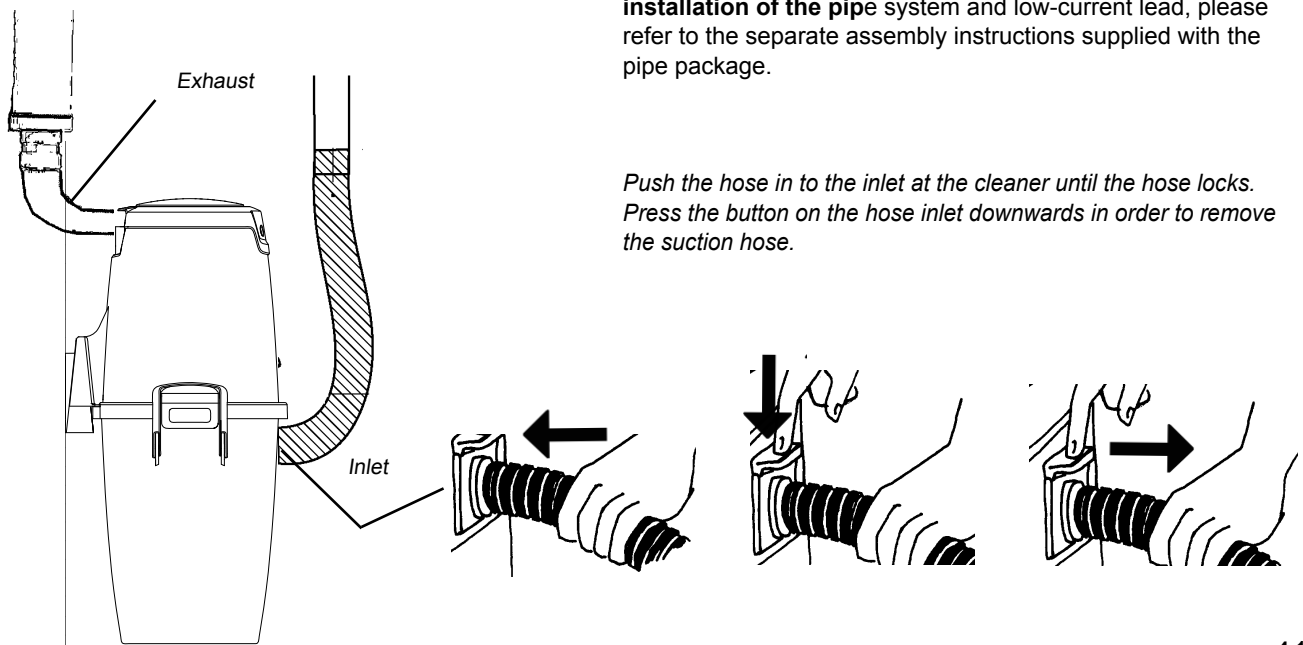

Fig. 17



5.1 Fitting the wall bracket

Plan the positioning of the wall bracket so that there is plenty of space above and below the area where the vacuum unit is to be located. Make sure there is a minimum of 200 mm free space below the dust container.

Mark the positions for all four screw holes with a pen or similar. The diameter of the holes in the holder is 5 mm. Select screws and, if necessary, wall plugs suitable for the type of wall concerned. Drill the four screw holes.

Fit the wall bracket with the large opening pointing downwards, see Fig. 15. Then screw the holder firmly into place.

5.2 Locating the vacuum cleaner on the wall bracket

To facilitate the procedure, first remove the dust container. Free the container by pulling both handles outwards. Then remove the container from the machine. To mount the vacuum cleaner/motor chassis to the wall bracket - just lower the chassis downwards so that the locking device of the bracket will pass through the slot of the chassis Fig. 16. Make sure the corresponding bracket on the machine is held firmly in place by the wall bracket.

When removing the motor chassis from the wall bracket - push the locking device towards you so it will release the chassis and then lift the chassis up from bracket.

5.3 Connecting the machine

The machine is connected with the flexible suction hose in the lower position and the exhaust pipe uppermost, Fig 17. The flexible hose is connected to the dust inlet at the container of the cleaner. Push the hose in to the inlet at the cleaner until the hose locks. Press the button on the hose inlet downwards in order to remove the suction hose. The flexible suction hose acts as an adapter connecting the vacuum unit with the pipe system.

NB! These connections must not be glued in case the unit is handed in for service.

Position the central vacuum cleaner so that the exhaust pipe can be kept as short as possible, maximum. 5 metres. Take the surroundings into consideration when positioning the exhaust. For this reason, you should always fit a muffler.

For additional information concerning the assembly and installation of the pipe system and low-current lead, please refer to the separate assembly instructions supplied with the pipe package.

Push the hose in to the inlet at the cleaner until the hose locks. Press the button on the hose inlet downwards in order to remove the suction hose.

5.4 Utility inlet (Standard accessory in Canada)

If you need an extra inlet on the machine, you can attach the utility inlet directly to the inlet on the vacuum cleaner and attach the flexible hose to the utility inlet.

The utility inlet can be used with both Manual, On/off and Wireless hoses. Just connect the vacuum hose to the inlet and push the on/off button on the cleaner to start vacuum cleaning.

If the lid is not fully closed when detaching the hose, it will automatically close next time the cleaner is started.

6 Operating instructions Supreme 150 / Performer 150 / Supreme 250 / Performer 250 / Supreme LCD

6.1 Starting the machine

The control current outlet (low voltage) is connected to a control current lead running the length of the pipes. Both ends of the low-voltage lead should be connected to the connection panel on the vacuum unit. One lead to each outlet.

The central vacuum cleaner's power cable must be connected to a 230 volt mains socket. The appliance is double-insulated and does not need to be earthed.

Start/stop button

All models have a start/stop button on the front to start and stop the power unit, Fig. 18. The start/stop button can also be used when/if you want to use a Nilfisk utility inlet to vacuum direct from the machine (if you do not have a Nilfisk hose with remote control) or for testing and demos.

Fig. 18

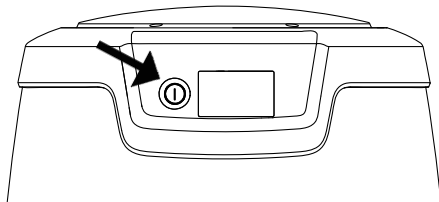

On/Off hose

Some models have an hose with remote control (on/off function) for the vacuum cleaner. The hose for these models are to be connected as shown in Fig. 19. NOTE! The plate at the hose inlet must be turned upwards, so that the hose inlet will be locked to the wall inlet by the two notches at the wall inlet.

Wireless handle

If you use a hose with a wireless handle, you can start and stop the vacuum cleaner using the switch on the handle, Fig. 20. Wireless handles have also the feature of adjusting the suction power of the cleaner, using buttons at the hose handle.

Fig. 20

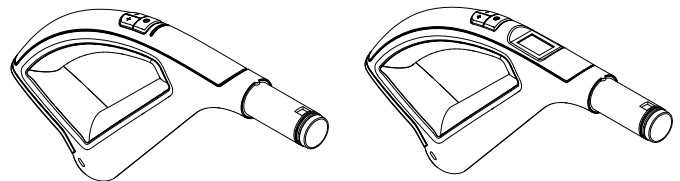

Wireless

Deluxe

6.2 Servicing

Always unplug the power cable before doing any service work! If suction is poor, it indicates that the flow of air through the machine is restricted. This may be due to the following:

- The dust bag is full and should be replaced.
- The filter is clogged and should be cleaned of dust.

Thermal protector

The vacuum cleaner has a thermal cut-out that trips if the vacuum cleaner becomes overheated.

Supreme 150 / Performer 150 / Supreme 250 / Performer 250

If this happens - unplug the main power cord to reset the vacuum cleaner. Wait 5-10 minutes to allow the machine to cool down. While you are waiting, check the hose, dust bag and filter to be sure that nothing is blocking the flow of air through the machine. The vacuum cleaner should now start again. If the cut-out trips again, you need to get a service firm to remedy the fault.

Supreme LCD

When the overheat symbol in the display on the cleaner is activated (models with display) the cleaners' thermal cut-out has tripped. For more information regarding thermal cut out, see Overheat indicator.

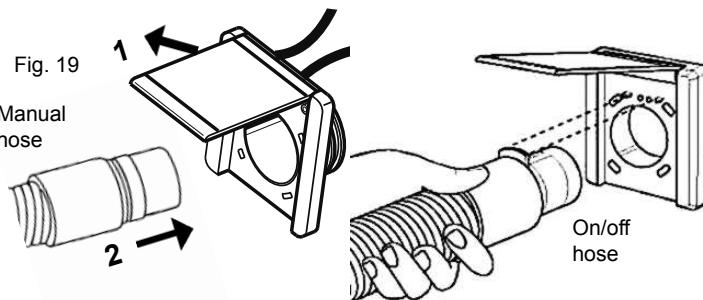

Fig. 19

Manual hose

On/off hose

Manual hose

The vacuum cleaner starts and stops automatically. When the vacuum hose is connected to a vacuum socket, a metal ring on the end of the hose closes the control circuit and the vacuum cleaner starts up. Fig. 19. When the hose is removed from the vacuum socket, the vacuum cleaner stops.

6.3 Supreme LCD Display

The Supreme LCD model has a display giving information about the machine, Fig. 21.

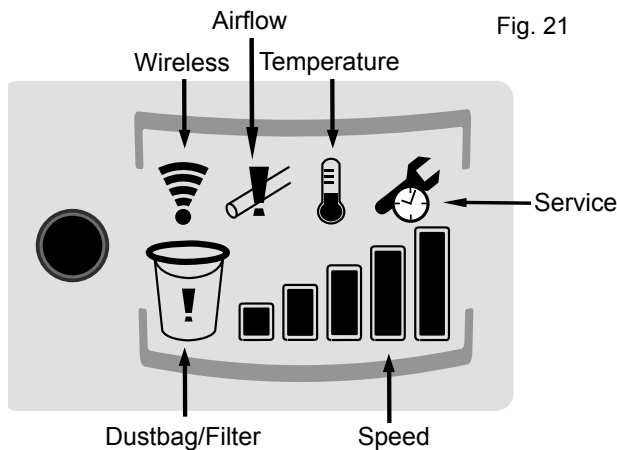

Fig. 21

While you are waiting, check the hose, dust bag and filter to be sure that nothing is blocking the flow of air through the machine.

Signal indicator - flashing

When the symbol is flashing, the hose handle is out of range and there is no connection to the cleaner. The cleaner will automatically stop after 30 min. if the hose handle or the cleaner has not been activated.



Speed level

When the start button is pushed or the hose is connected to the wall socket, the display will turn on and show the speed level.



Dust bag/bag filter indicator

When the dust bag/filter symbol starts to flash during operation, the cleaner tells you that it is almost time to clean the bag filter and replace the dust bag. When it is time to do so, symbol will be lit continuously. The dust bag/filter symbol will be lightened after every 20 operation hours of the cleaner at the latest. If the symbol is lit, do like this: Turn off the cleaner by the hose handle (remote versions) or remove the suction hose from the wall inlet (manual hose versions) or by pushing the on/off switch on the display. Then check if the bag filter/dust bag is clogged. Replacement is described in chapters 7.1, 7.2, 7.3 and 7.4.

In switched off mode, re-set run time counter by holding the start/stop button down until the dust bag indicator goes out (after approx. 5 sec.).



Reduced airflow indicator - lit

The reduced airflow symbol on the display indicates that the airflow through the vacuum cleaner is reduced. After 30 seconds of operation with reduced airflow, the vacuum motor will be shot down in order to prevent damage to the motor. If the reduced airflow symbol is lit and the motor has been shut down, do like this: Check the bag filter and dust bag (see chapters 7.1, 7.2, 7.3 and 7.4) to see if anything is blocking the airflow. Remove the material causing the reduced airflow symbol to indicate.



Service indicator

When the service symbol starts flashing, the motor will run for one more hour before it stops/will not start. The purpose of the service symbol is to inform you that it is time to order service of the cleaner. When the symbol is continuously lit, the run time counter in the cleaner has counted that the allowed amount of run time has passed. You must now contact an authorised service workshop and let them perform a service of the cleaner and to reset the run time counter.



Overheat indicator - flashing

The overheat symbol indicates that the cleaner has become overheated. The cleaner stops automatically. Unplug the main power cord to reset the vacuum cleaner and wait 5-10 minutes to allow the machine to cool down.



7 Filter and dust bags - Supreme 150 / Performer 150 / Supreme 250 / Performer 250 / Supreme LCD

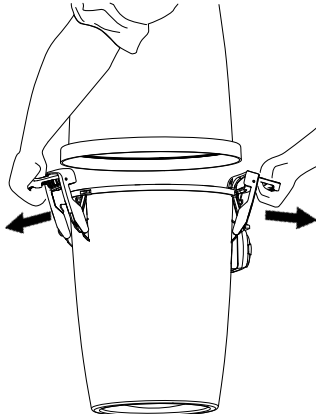

Fig. 22

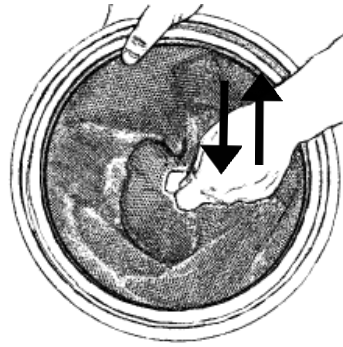

Fig. 23

7.1 Replacing the bag filter

A bag filter must always be installed in the dust container. Clean the filter in the following way:

1. Release the two handles clamping the dust container. The handles are easily unlocked by lifting up the handles until they come to a stop. When you pull the handles outwards away from the cleaner, the container is released. Fig. 22.
2. Do not remove the filter from the container. Instead, give the filter a light shaking inside the container to loosen dust from the filter allowing it to fall into the container. This is done by grasping the strap on the filter and quickly move the filter up and down as shown in Fig. 23.
3. Lift out the bag filter. If a dust bag is being used - remove the dust bag. Then empty the container of any remaining dust in a suitable place.

7.2 Fitting the bag filter

Replace the bag filter in the machine as follows:

1. Replace the cleaned/shaken bag filter in the container. Make sure the filter support fits into the inner edge of the dust container properly. Check that the filter is fitted the right way up - the cloth handle on the filter should be visible.
2. Then replace the dust container with the bag filter in the cleaner's vacuum unit.
3. Attach the container on the vacuum unit by lifting the container back in place and pushing the handles back in over the edge of the cleaner till you hear a click. Push down the handles and ensure that the vacuum unit and dust container are fitted together properly.

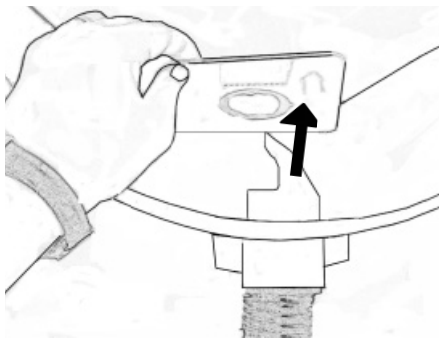

Fig. 24

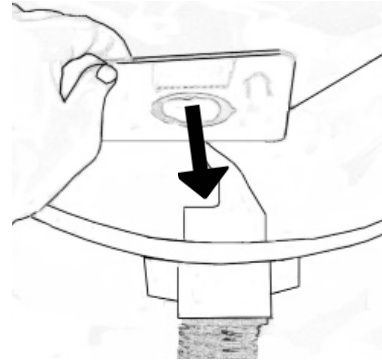

Fig. 25

7.3 Replacing the dust bag

The machine is supplied with a dust bag. Replace the dust bag in the following way:

1. Release the two handles clamped on to the dust container. The handles are easily unlocked by lifting up the handles until they come to a stop. When you pull the handles outwards away from the cleaner, the container is released. Fig. 22.
2. Lift off the container.
3. Shake the dust from the bag filter. It may be advantageous for the filter to be installed in the container in such a way that dust in the filter can be shaken down into the dust container.
4. Lift out the bag filter.
5. Remove the dust bag by taking hold of the cardboard stiffener and carefully pulling out the card and bag from the container, Fig. 24. Fold down the perforated part of the cardboard towards the opening of the bag in order to prevent the bag contents to leak out.
6. Empty the container of dust.

7.4 Fitting the dust bag

Replace the dust bag as follows:

1. Fit the dust bag's card with a hole into the bag holder, Fig. 25.
2. Replace the cleaned/shaken bag filter in the container. Make sure the filter support fits into the inner edge of the dust container properly. Check that the filter is fitted the right way up - the cloth handle on the filter should be visible.
3. Replace the dust container on the vacuum unit. Close the container on the vacuum unit by applying inward pressure to the two handles to ensure the vacuum unit and dust container are fitted together properly.

The Supreme 150 / Performer 150 / Supreme 250 / Performer 250 / Supreme LCD can be run with or without the installation of a dust bag - the choice is yours. These products must though always be operated with the bag filter fitted in the cleaner.

8 Electrical connection

On/Off

The control current outlet (low voltage) is connected to a control current lead running the length of the pipes. Both ends of the low-voltage lead are connected to the connection panel on the vacuum unit. One lead to each outlet. The low-voltage lead should be connected as informed below.

Location of the outlet for the low-voltage cables:

Supreme 100

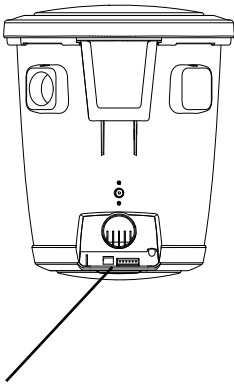

Supreme 100

The connection panel is located in the bottom of the vacuum unit.

Supreme 150 / Performer 150 / Supreme 250 / Performer 250 / Supreme LCD

The connection panel is located in the top of the vacuum unit

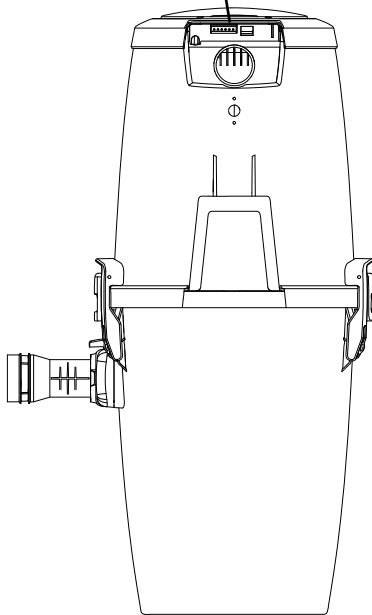

Connection panel

All models have the low voltage cable connector placed to the left on the panel. These models do also have two extra outlets on the panel. These outlets are prepared for future functions and are not in use for the moment. The connector for the cable to the transceiver box is placed to the right.

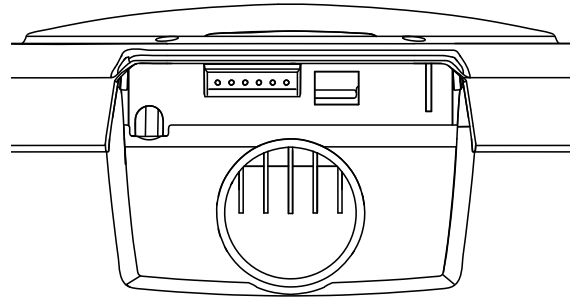

Connection of the low voltage cables

The low voltage cables that runs along the pipes, is to be connected to the connector at the vacuum cleaner. Connect the ends of cables in the electrical sockets, one cable end in each socket. Secure the low voltage cables by pulling the snap lockings at the connector, downwards.

Secure the low voltage cables at the connector - pull the snap lockings at the connector downwards.

Connector

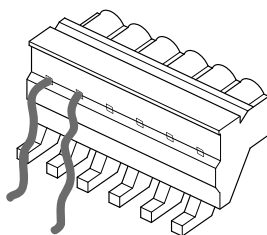

Low voltage cable

9 Accessories

Telescopic tube

Adjust the length of the telescopic tube by pressing/pulling the regulator and sliding the tube it in or out, Fig. 26.

(For cleaning stairs, we recommend reducing the length of the tube to the minimum.)

Fig. 26

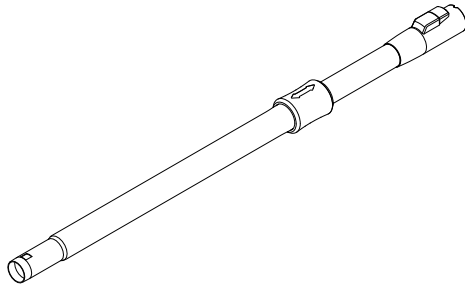

Standard floor nozzle

This is a universal, lightweight floor nozzle that can be used on most floor surfaces. You can switch from cleaning carpets to parquet or other flooring, Fig. 27/28.

Fig. 27

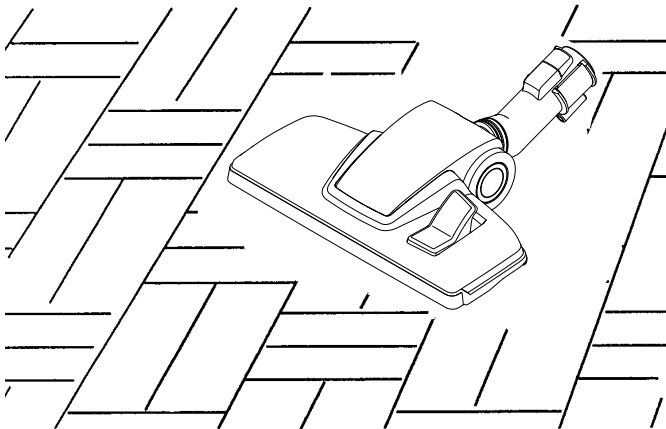
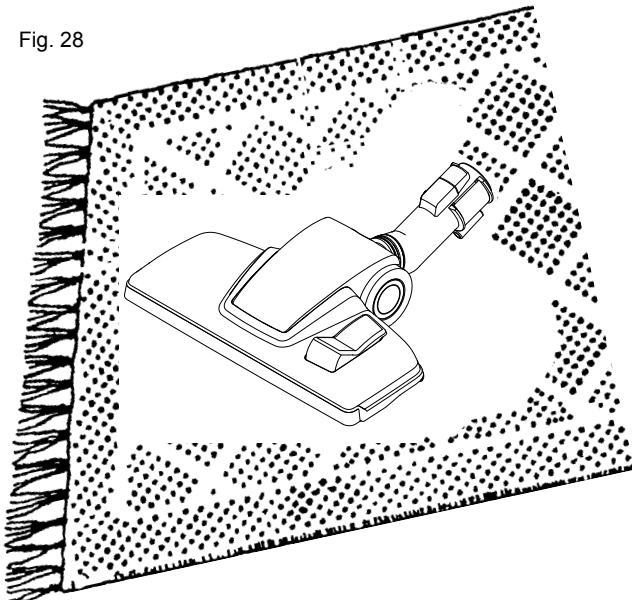

Fig. 28



Radiator/crevice nozzle

This nozzle is useful for hard-to-reach, restricted areas such as corners, crevices and radiators.

Fig. 29

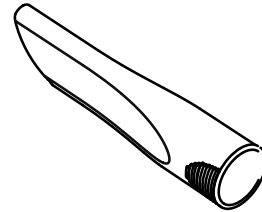

Dusting brush

The dusting brush can be used on lamps, pictures, curtains and other textiles, Fig. 30

Fig. 30

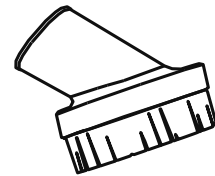

Furniture nozzle

Small, practical nozzle for vacuuming furniture, cushions and textiles, Fig. 31.

Fig. 31

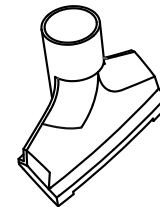

Remember!
Never vacuum up liquids, broken glass or hot ashes, Fig. 32.

Fig. 32

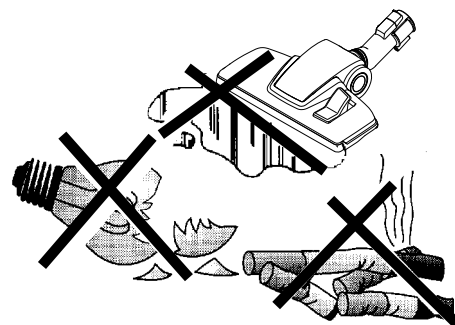

10 Troubleshooting

All work involving the 240 volt mains electricity supply must be carried out by a qualified electrical contractor with full knowledge of the relevant safety regulations.

The vacuum cleaner will not start Thermal protector

The vacuum cleaner has a thermal cut-out that trips if the vacuum cleaner becomes overheated.

Supreme 100 / Supreme 150 / Performer 150 / Supreme 250 / Performer 250

If this happens - unplug the main power cord to reset the vacuum cleaner. Wait 5-10 minutes to allow the machine to cool down. While you are waiting, check the hose, dust bag and filter to be sure that nothing is blocking the flow of air through the machine. The vacuum cleaner should now start again. If the cut-out trips again, you need to get a service firm to remedy the fault.

Supreme LCD

When the overheat symbol in the display on the cleaner is activated (models with display) the cleaners' thermal cut-out has tripped. For more information regarding thermal cut out, see Overheat indicator.

Other troubleshootings

- Are you using the correct hose?
Only the original hoses fit correctly.
- Does the vacuum cleaner start when you try a different vacuum socket? If so, there is a fault in the electrical connection to the first socket. Unscrew the socket and check the connection at the back.
- Is the power supply connected to the vacuum unit?
- Is there power at the socket?
- Is the low-voltage lead connected to the vacuum unit?
- The batteries to the radio remote control (wireless version of vacuum cleaner) may have been discharged. Replace the batteries with new ones, type 1.5V AAA.

The vacuum cleaner will not stop

- Has a metal object become lodged in one of the vacuum sockets causing the pins to become fused?

Poor suction power

- Are all the vacuum sockets closed properly?
- Has something become jammed in one of the vacuum sockets?
- Is the container lid closed properly?
- Is the gasket between the container and the lid in place?
- Is it damaged?
- Is the pipe system blocked?
- Is the dust bag full or clogged?
- Is filter clogged?

Supreme LCD Display

The Supreme LCD model has a display giving information about the machine, Fig. 21.

Speed level

When the start button is pushed or the hose is connected to the wall socket, the display will turn on and show the speed level.

Dust bag/bag filter indicator

When the dust bag/filter symbol starts to flash during operation, the cleaner tells you that it is almost time to clean the bag filter and replace the dustbag. When it is time to do so, symbol will be lit continuously. The dust bag/filter symbol will be lightened after every 20 operation hours of the cleaner. If the symbol is lit, do like this: Turn off the cleaner by the hose handle (remote versions) or remove the suction hose from the wall inlet or by pushing the on/off switch on the display. Then check if the bag filter/dustbag is clogged. Replacement is described in chapters 7.1, 7.2, 7.3 and 7.4. In switched off mode, re-set run time counter by holding the start/stop button down until the dust bag indicator goes out (after approx. 5 sec.).

Reduced airflow indicator - lit

The reduced airflow symbol on the display indicates that the airflow through the vacuum cleaner is reduced. After 30 seconds of operation with reduced airflow, the vacuum motor will be shot down in order to prevent damage to the motor. If the reduced airflow symbol is lit and the motor has been shut down, do like this: Check the bag filter and dust bag (see chapters 7.1, 7.2, 7.3 and 7.4) to see if anything is blocking the airflow. Remove the material causing the reduced air flow symbol to indicate.

Service indicator

When the service symbol starts flashing, the motor will run for one more hour before it stops/will not start. The purpose of the service symbol is to inform you that it is time to order service of the cleaner. When the symbol is continuously lit, the run time counter in the cleaner has counted that the allowed amount of run time has passed. You must now contact an authorised service workshop and let them perform a service of the cleaner and to reset the run time counter.

Overheat indicator - flashing

The overheat symbol indicates that the cleaner has become overheated. The cleaner stops automatically. Unplug the main power cord to reset the vacuum cleaner and wait 5-10 minutes to allow the machine to cool down. While you are waiting, check the hose, dust bag and filter to be sure that nothing is blocking the flow of air through the machine.

Signal indicator - flashing

When the symbol is flashing, the hose handle is out of range and there is no connection to the cleaner. The cleaner will automatically stop after 30 min. if the hose handle or the cleaner has not been activated.

WARNING!

Blockages can occur if:

- a) the tools and accessories are not used as directed at all times.**
- b) wet or damp carpets are vacuumed.**
- c) foreign objects are vacuumed up when the tools are not affixed to the hose.**
- d) the wall sockets are not kept open until the system motor stops completely**
- e) the filter and bags are not regularly cleaned and replaced as per manufacturers instructions.**

NB! Blockages are caused by misuse and are not covered by the guarantee or warranty.

10.1 Service/maintenance guide - Supreme 100

NB! Never vacuum without a filter and dust bag installed in the model Supreme 100



Product	How often?	Why?	How?
Dust bag	Should be replaced before it becomes completely full, depending on use but normally 2-4 times a year.	Poor suction and danger of creating a blockage in the pipe system.	Grasp the edge of the lid and open it by pulling upwards. Remove the old dust bag by turning the cardboard stiffener to the right or left so that the elevation on the nozzle penetrates the opening in the cardboard. Now slide the bag off the inlet. Push the opening in the cardboard over the elevation on the inlet and pull on the new bag. Twist the cardboard to lock the bag in place. NB! The opening in the card must be adjusted and pushed past the elevation on the inlet before the cardboard can be locked into place with a twisting action. NB! Never vacuum without a dust bag installed.
Filter in bottom	Should be checked when changing the bag.	Poor suction can result. Dust can find its way into the motor.	Remove the dust bag as described above. Remove the filter from the bottom. The filter can be cleaned by shaking it or washing it in water. NB! The filter must be completely dry before being reinstalled. Replace the cleaned filter in the machine. Press the outer edge of the filter down against the sides of the container so that the filter bulges up slightly. Refit the dust bag and replace the lid. Check that the lid is sitting firmly in place. NB! Never vacuum without a filter installed.

10.2 Service/maintenance guide - Supreme 150 / Performer 150 / Supreme 250 / Performer 250 / Supreme LCD

NB! Never vacuum without a filter installed.

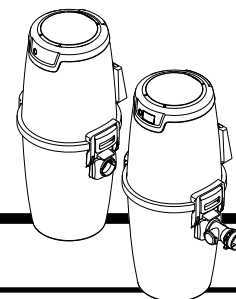

Product	How often?	Why?	How?
Dust container	Should be emptied before the container is 3/4 full, depending on use but normally 2-4 times a year.	Danger of blockage in the pipe system.	Release the two handles clamping the dust container. The handles are easily unlocked by lifting up the handles until they come to a stop. When you pull the handles outwards away from the cleaner, the container is released. Lift off the container. Lift out the filter and dust bag - see additional information below. Empty the dust into a plastic bag and put in dustbin. Any remaining dust or fluff can be removed manually.
Dust bag	Should be replaced before it becomes completely full, depending on use but normally 2-4 times a year.	Poor suction and danger of creating a blockage in the pipe system.	Release the two handles clamping the dust container. The handles are easily unlocked by lifting up the handles until they come to a stop. When you pull the handles outwards away from the cleaner, the container is released. Lift off the container. Lift out the filter. Then remove the dust bag by pulling the bag's cardboard stiffener off the nozzle. Replace in reverse order.
Filter	Should be shaken when the container is emptied. NB: Only use dry cleaning methods	To maintain good suction power.	Release the two handles clamping the dust container. The handles are easily unlocked by lifting up the handles until they come to a stop. When you pull the handles outwards away from the cleaner, the container is released. Lift off the container. Do not remove the filter from the container. Instead, give the filter a light shaking inside the container to loosen dust from the filter and allow it to fall into the container. Lift out the bag filter. If a dust bag is being used - remove it. Then empty the dust from the container in a suitable place.

11 Dimensional drawings

Dimensional drawings in mm.

Supreme 100

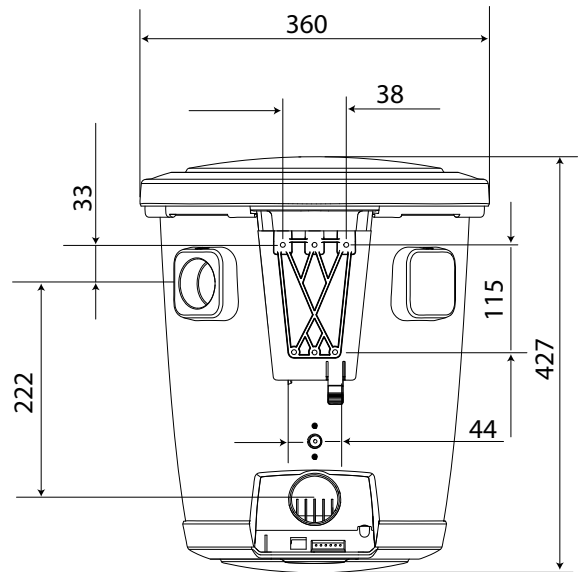
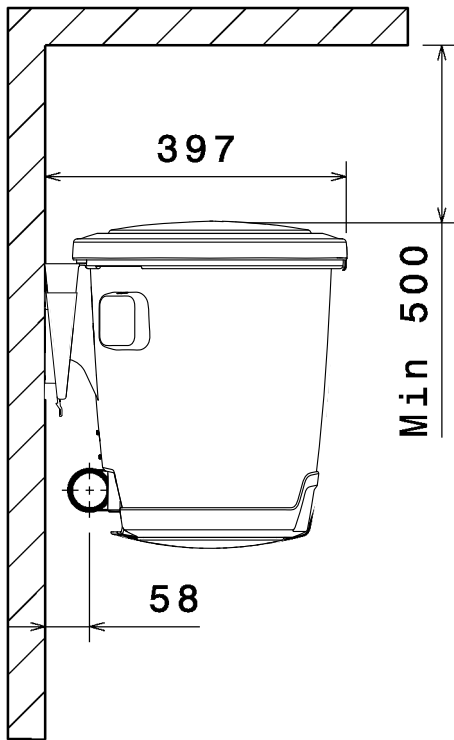

Supreme 150 / Performer 150 / Supreme 250 / Performer 250 / Supreme LCD

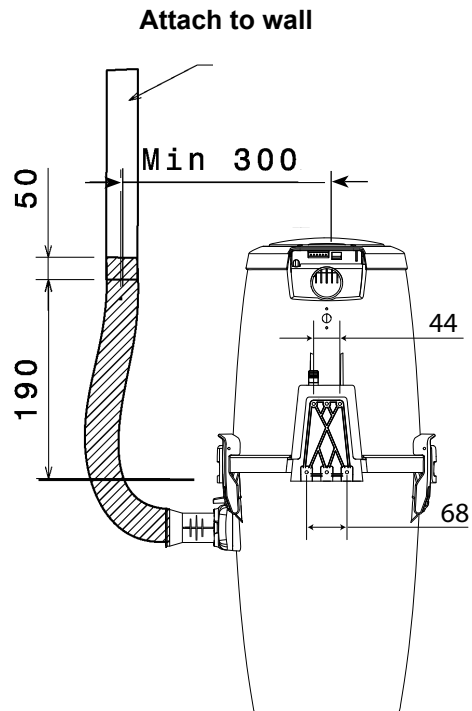
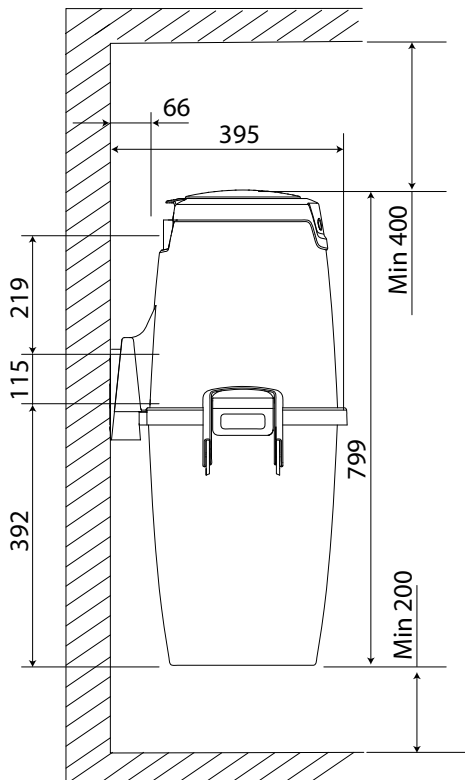

12 Wireless communication - Wireless+/Deluxe

WARNING!

Do not pull out the suction hose from the cleaner while the motor/fan unit of the cleaner is running. These machines have a safety shut off function. This shut off function will be activated when the machine is operated with a closed vacuum socket.

12.1 Transceiver box

Before you mount the transceiver box to the wall you should always test if you have a signal between the transceiver box and the hose handle in your entire home. Connect the box to the cleaner and turn the cleaner on and off using the hose handle from different places in your home.

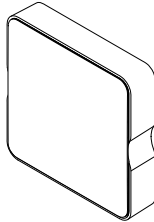

The first transmission

The hose handle and the cleaner needs to have a first communication before starting the cleaner. This is also valid if the hose handle has been replaced (spare part) or if you want to connect an extra hose. Do like this before starting your wireless cleaner:

- 1) Unplug the main cord.
- 2) Plug in the cord again, and then push the on/off button at the hose handle for approximately 10 seconds. This must be done within 60 seconds after the cleaner has been plugged in
- 3) The handle and the cleaner do now communicate.

Installing the transceiver box

Mount the transceiver box on the wall minimum 1 meter away from the cleaner for best signal between the transceiver box and the hose handle. The transceiver box can be moved to different places in your home for a better range by using an up to 30 meter network cable. Cables can often be bought in your local Electronics store.

Connecting the transceiver box

To be able to use the wireless Nilfisk hose handles, you must first connect the transceiver box to the cleaner. This is done by using the 2 meter the network cable (RJ45) that comes with the transceiver box. Connect the cable to the transceiver box and the right socket in the back of the cleaner.

12.2 Wireless hose handle

Instruction for use

The on-off function and power regulation is controlled by radio technology. You do not have to point at the machine like infrared controls. The wireless bent end can be used anywhere in the house.

Start and stop

Start: One push at the switch will start the cleaner.
Stop: One push at the switch will shut off the cleaner.
The power regulation can be adjusted in 5 steps. You switch between the different steps by pressing the (+) or (-) buttons at the hose handle.

Wireless

The LED-indicator is placed above the on/off button and will be activated with different lights depending on the actions that are taken:

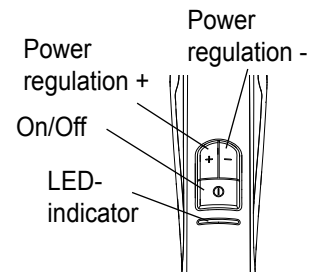

The lamp is activated at start or stop actions or when the power regulation is adjusted. The lamp flashes a warning light that indicates that the bag filter/dust bag is clogged and needs cleaning/replacement. You must then check and clean or replace the filter/bag.

Deluxe info center display

The display is placed above the on/off button and will show different symbols depending of the status of the cleaner.

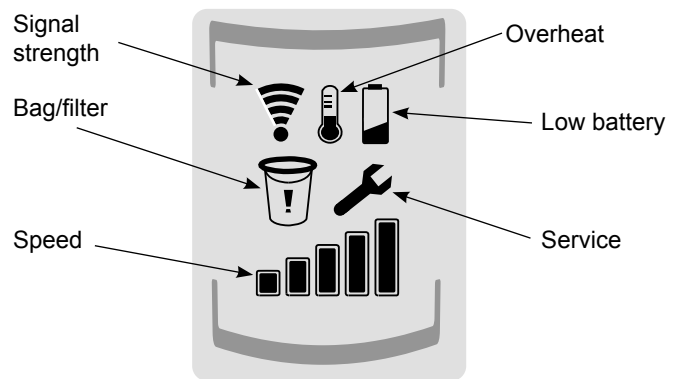

Speed level: Bars shows the actual speed level

Low Battery flashing: Battery is under 5%, Change battery.

Service warning / Air flow blocked lit: Indicates for both Service warning and Blocked airflow. See 10 Troubleshooting

Check bag/filter flashing: It is almost time to change dust bag and clean filter.

Check bag/filter lit: Dust bag or filter is clogged. Change dust bag and clean filter.

Signal flashing: Hose handle is out of range. No connection to the cleaner.

Overheat flashing: Thermal cut-out has tripped and the cleaner has stopped. See 10 Troubleshooting



Battery



The lifetime of the enclosed batteries in the bent end is approximately three (3) years. If the battery capacity at operation start is to low, the cleaner will then be shut off. If the cleaner would not start or the power regulation via the hose handle does not work, you must replace the batteries at the hose handle. Replace to battery type 1.5V AAA. For more information and trouble shooting see chapter 10 in this instruction for use.



How to replace battery at the hose handle



- 1) Open the lid of the battery holder by sliding the lid towards the front of the hose handle.
- 2) Replace the used batteries with two new ones, type 1.5V AAA. Make sure the polarity of the batteries is placed correct at the bracket.
- 3) Slide the battery lid back until you hear a click.





 Konformit�tserkl�ring	
Produkt:	Staubsauger
Typ:	Nilfisk Zentralstaubsauger, Performer & Supreme
Beschreibung:	107404969, 107404970, 107404971, 107404972, 107404974, 107404975
Das Design des Ger�ts entspricht den folgenden relevanten Vorschriften:	EU-Maschinenrichtlinie 2006/42/EG EU-Richtlinie zur elektromagnetischen Vertr�glichkeit 2004/108/EG EU-RoHS-Richtlinie 2011/65/EG
Angewendete harmonisierte Normen:	EN 55014-1: 2006 + A1: 2009 & A2: 2011 EN 61000-3-2: 2006 + A1: 2009 & A2: 2009 EN 61000-3-3: 2008 EN 55014-2: 1997 + A1: 2001 & A2: 2008 EN 301 489-1 V1.9.2 (2011-09) EN 301 489-3 V1.4.1 (2002-08) EN 3000220-2 V2.3.1 (2010-02) EN 3000220-1 V2.3.1 (2010-02) FCC Part 15C (2011) RSS-Gen (issue 3) (December 2010) RSS-210 (issue 8) (December 2010) IEC/EN 60335-1 5th ed. (2012) IEC/EN 60335-2-69 5th ed. (2012) IEC 60335-1 fifth ed. (2001)+A1+A2 IEC 60335-2-2 (2002)+A1+A2 IEC 60335-2-2: 2009 IEC 60335-1:2001+ A1:2004 + A2:2006 EN 60335-2-2:2010+A11 EN 60335-1:2002 +A11+A1+A12+A2+A13 +A14+A15 EN 62233:2008
Angewendete nationale Normen und technische Spezifikationen:	IEC 60335-2-2 IEC 60335-2-69
Name und Anschrift der Person, die bevollm�chtigt ist, die technische Unterlagen zusammenzustellen:	Anton S�rensen General Manager, Technical Operations EAPC Nilfisk A/S Kornmarksvej 1 DK-2605 Broendby
Identit�t und Unterschrift der Person, die bevollm�chtigt ist, die Erkl�rung im Namen des Herstellers auszustellen:	 Anton S�rensen General Manager, Technical Operations EAPC Nilfisk A/S Kornmarksvej 1 DK-2605 Broendby
Ort und Datum der Erkl�rung	Hadsund, 06.03.2013

 F�rs�kran om �verensst�mmelse	
Produkt:	Dammsugare
Typ:	Nilfisk centraldammsugare, Performer & Supreme
Beskrivning	107404969, 107404970, 107404971, 107404972, 107404974, 107404975
Apparatens konstruktion motsvarar f�ljande till�mpliga best�mmelser:	EG-maskindirektiv 2006/42/EC EG-direktiv EMC 2004/108/EC EU:s RoHS-direktiv 2011/65/EC
Till�mpade harmoniserade normer:	EN 55014-1: 2006 + A1: 2009 & A2: 2011 EN 61000-3-2: 2006 + A1: 2009 & A2: 2009 EN 61000-3-3: 2008 EN 55014-2: 1997 + A1: 2001 & A2: 2008 EN 301 489-1 V1.9.2 (2011-09) EN 301 489-3 V1.4.1 (2002-08) EN 3000220-2 V2.3.1 (2010-02) EN 3000220-1 V2.3.1 (2010-02) FCC Part 15C (2011) RSS-Gen (issue 3) (December 2010) RSS-210 (issue 8) (December 2010) IEC/EN 60335-1 5th ed. (2012) IEC/EN 60335-2-69 5th ed. (2012) IEC 60335-1 fifth ed. (2001)+A1+A2 IEC 60335-2-2 (2002)+A1+A2 IEC 60335-2-2: 2009 IEC 60335-1:2001+ A1:2004 + A2:2006 EN 60335-2-2:2010+A11 EN 60335-1:2002 +A11+A1+A12+A2+A13 +A14+A15 EN 62233:2008
Till�mpade nationella normer och tekniska specifikationer:	IEC 60335-2-2 IEC 60335-2-69
Namn och adress p� person som �r beh�rig att sammanst�lla den tekniska filen:	Anton S�rensen General Manager, Technical Operations EAPC Nilfisk A/S Kornmarksvej 1 DK-2605 Broendby
Personnummer och underskrift f�r den person som �r beh�rig att uppr�tta deklARATIONEN � tillverkarens v�gnar:	 Anton S�rensen General Manager, Technical Operations EAPC Nilfisk A/S Kornmarksvej 1 DK-2605 Broendby
Plats och datum f�r f�rs�kran:	Hadsund, 06.03.2013

 Declaration of Conformity	
Product:	Vacuum Cleaner
Type:	Nilfisk Central vacuum cleaner, Performer & Supreme
Description:	107404969, 107404970, 107404971, 107404972, 107404974, 107404975
The design of the unit corresponds to the following pertinent regulations:	EC Low-voltage Directive 2006/95/EC EC EMC Directive 2004/108/EC RoHS Directive 2011/65/EC
Applied harmonised standards:	EN 55014-1: 2006 + A1: 2009 & A2: 2011 EN 61000-3-2: 2006 + A1: 2009 & A2: 2009 EN 61000-3-3: 2008 EN 55014-2: 1997 + A1: 2001 & A2: 2008 EN 301 489-1 V1.9.2 (2011-09) EN 301 489-3 V1.4.1 (2002-08) EN 3000220-2 V2.3.1 (2010-02) EN 3000220-1 V2.3.1 (2010-02) FCC Part 15C (2011) RSS-Gen (issue 3) (December 2010) RSS-210 (issue 8) (December 2010) IEC/EN 60335-1 5th ed. (2012) IEC/EN 60335-2-69 5th ed. (2012) IEC 60335-1 fifth ed. (2001)+A1+A2 IEC 60335-2-2 (2002)+A1+A2 IEC 60335-2-2: 2009 IEC 60335-1:2001+ A1:2004 + A2:2006 EN 60335-2-2:2010+A11 EN 60335-1:2002 +A11+A1+A12+A2+A13 +A14+A15 EN 62233:2008
Applied national standards and technical specifications:	IEC 60335-2-2 IEC 60335-2-69
Name and address of the person authorised to compile the technical file:	Anton Sørensen General Manager, Technical Operations EAPC Nilfisk A/S Kornmarksvej 1 DK-2605 Broendby
Identity and signature of the person empowered to draw up the declaration on behalf of the manufacturer:	 Anton Sørensen General Manager, Technical Operations EAPC Nilfisk A/S Kornmarksvej 1 DK-2605 Broendby
Place and date of the declaration	Hadsund, 06.03.2013

 Vakuutus	
Tuote:	Pölynimuri
Tyyppi:	Nilfisk Keskuspölynimuri, Performer & Supreme
Kuvaus:	107404969, 107404970, 107404971, 107404972, 107404974, 107404975
Laite vastaa seuraavia määräyksiä:	EU:n matalajännittdirektiivi 2006/95/EC EU:n EMV-direktiivi 2004/108/EC RoHS direktiivi 2011/65/EC
Käytettävät harmonisoidut standardit:	EN 55014-1: 2006 + A1: 2009 & A2: 2011 EN 61000-3-2: 2006 + A1: 2009 & A2: 2009 EN 61000-3-3: 2008 EN 55014-2: 1997 + A1: 2001 & A2: 2008 EN 301 489-1 V1.9.2 (2011-09) EN 301 489-3 V1.4.1 (2002-08) EN 3000220-2 V2.3.1 (2010-02) EN 3000220-1 V2.3.1 (2010-02) FCC Part 15C (2011) RSS-Gen (issue 3) (December 2010) RSS-210 (issue 8) (December 2010) IEC/EN 60335-1 5th ed. (2012) IEC/EN 60335-2-69 5th ed. (2012) IEC 60335-1 fifth ed. (2001)+A1+A2 IEC 60335-2-2 (2002)+A1+A2 IEC 60335-2-2: 2009 IEC 60335-1:2001+ A1:2004 + A2:2006 EN 60335-2-2:2010+A11 EN 60335-1:2002 +A11+A1+A12+A2+A13 +A14+A15 EN 62233:2008
Käytettävät kansalliset standardit ja tekniset tiedot:	IEC 60335-2-2 IEC 60335-2-69
Teknisten tietojen valtuutetun laatijan nimi ja osoite:	Anton Sørensen General Manager, Technical Operations EAPC Nilfisk A/S Kornmarksvej 1 DK-2605 Broendby
Valmistajan puolesta valtuutetun vakuutuksen laatijan henkilöllisyys ja allekirjoitus:	 Anton Sørensen General Manager, Technical Operations EAPC Nilfisk A/S Kornmarksvej 1 DK-2605 Broendby
Vakuutuksen antamisen paikka ja päiväys:	Hadsund, 06.03.2013

 Erklæring	
Produkt:	Vacuum Cleaner
Type:	Nilfisk centralstøvsuger, Performer & Supreme
Beskrivelse:	107404969, 107404970, 107404971, 107404972, 107404974, 107404975
Maskinens design er i overensstemmelse med følgende relevante standarder:	EC Lavspændingsdirektivet 2006/95/EC EC EMC Direktivet 2004/108/EC RoHS Direktivet 20011/65/EC
Anvendte harmoniserede standarder:	EN 55014-1: 2006 + A1: 2009 & A2: 2011 EN 61000-3-2: 2006 + A1: 2009 & A2: 2009 EN 61000-3-3: 2008 EN 55014-2: 1997 + A1: 2001 & A2: 2008 EN 301 489-1 V1.9.2 (2011-09) EN 301 489-3 V1.4.1 (2002-08) EN 3000220-2 V2.3.1 (2010-02) EN 3000220-1 V2.3.1 (2010-02) FCC Part 15C (2011) RSS-Gen (issue 3) (December 2010) RSS-210 (issue 8) (December 2010) IEC/EN 60335-1 5th ed. (2012) IEC/EN 60335-2-69 5th ed. (2012) IEC 60335-1 fifth ed. (2001)+A1+A2 IEC 60335-2-2 (2002)+A1+A2 IEC 60335-2-2: 2009 IEC 60335-1:2001+ A1:2004 + A2:2006 EN 60335-2-2:2010+A11 EN 60335-1:2002 +A11+A1+A12+A2+A13 +A14+A15 EN 62233:2008
Anvendte nationale standarder og tekniske specifikationer:	IEC 60335-2-2 IEC 60335-2-69
Navn og adresse på den person der er ansvarlig for den tekniske dokumentation	Anton Sørensen General Manager, Technical Operations EAPC Nilfisk A/S Kornmarksvej 1 DK-2605 Brøndby
Identitet og underskrift af den person, der er bemyndiget til at udarbejde erklæringen på vegne af fabrikanten:	 Anton Sørensen General Manager, Technical Operations EAPC Nilfisk A/S Kornmarksvej 1 DK-2605 Brøndby
Sted og dato for erklæringen:	Hadsund, 06.03.2013

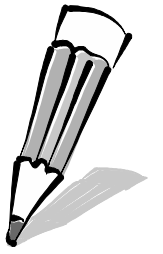

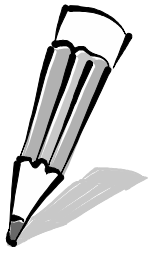

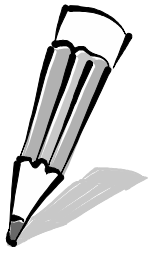
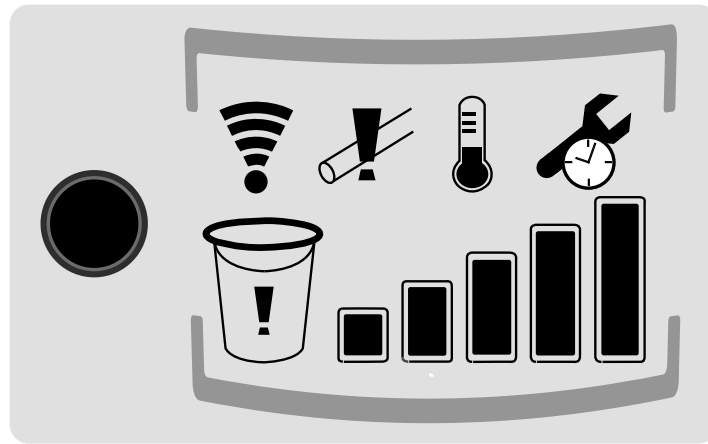

Table with explanation of the indication lights at the display for Supreme LCD















	Speed level 	Service 	Air flow 	Bag/filter 	Signal 	Overheating 
Signal lit	Bars show the actual speed level					
Signal flashing		Indicates for service warning. See 10 Troubleshooting	Indicates for blocked airflow. See 10 Troubleshooting	Dust bag or filter is clogged. Change dust bag and clean filter.	Hose handle is out of range. No connection to the cleaner.	Thermal cut-out has tripped and the cleaner has stopped. See 10 Troubleshooting

Table with explanation of the indication lights at the Deluxe Hose handle



	Speed level 	Battery 	Service 	Bag/filter 	Signal 	Overheating 
Signal lit	Bars show the actual speed level					
Signal flashing		Battery is under 5%. Change battery	Indicates for service warning. See 10 Troubleshooting	Dust bag or filter is clogged. Change dust bag and clean filter.	Hose handle is out of range. No connection to the cleaner.	Thermal cut-out has tripped and the cleaner has stopped. See 10 Troubleshooting



<http://www.nilfisk.com>

HEAD QUARTER

DENMARK

Nilfisk A/S
Kornmarksvej 1
DK-2605 Broendby
Tel.: (+45) 4323 8100
Website: www.nilfisk.com

SALES COMPANIES

ARGENTINA

Nilfisk srl.
Edificio Central Park
Herrera 1855, 6th floor/604
Ciudad de Buenos Aires
Tel.: (+54) 11 6091 1571
Website: www.nilfisk.com.ar

AUSTRALIA

Nilfisk Pty Ltd
Unit 1/13 Bessemer Street
Blacktown NSW 2148
Tel.: (+61) 2 98348100
Website: www.nilfisk.com.au

AUSTRIA

Nilfisk GmbH
Metzgerstrasse 68
5101 Bergheim bei Salzburg
Tel.: (+43) 662 456 400 90
Website: www.nilfisk.at

BELGIUM

Nilfisk n.v.-s.a.
Riverside Business Park
Boulevard Internationalelaan 55
Bâtiment C3/C4 Gebouw
Bruxelles 1070
Tel.: (+32) 14 67 60 50
Website: www.nilfisk.be

Brazil

Nilfisk do Brasil
Av. Eng. Luis Carlos Berrini, 550
40 Andar, Sala 03
SP - 04571-000 Sao Paulo
Tel.: (+11) 3959-0300 / 3945-4744
Website: www.nilfisk.com.br

CANADA

Nilfisk Canada Company
240 Superior Boulevard
Mississauga, Ontario L5T 2L2
Tel.: (+1) 800-668-8400
Website: www.nilfisk.ca

CHILE

Nilfisk S.A. (Comercial KCS Ltda)
Salar de Llamara 822
8320000 Santiago
Tel.: (+56) 2684 5000
Website: www.nilfisk.cl

CHINA

Nilfisk
4189 Yindu Road
Xinzhuang Industrial Park
201108 Shanghai
Tel.: (+86) 21 3323 2000
Website: www.nilfisk.cn

CZECH REPUBLIC

Nilfisk s.r.o.
VGP Park Horni Počernice
Do Čertous 1/2658
193 00 Praha 9
Tel.: (+420) 244 090 912
Website: www.nilfisk.cz

DENMARK

Nilfisk Danmark A/S
Kornmarksvej 1
2605 Brøndby
Tel.: (+45) 4323 4050
E-mail: kundeservice.dk@nilfisk.com

FINLAND

Nilfisk Oy Ab
Koskelontie 23 E
02920 Espoo
Tel.: (+358) 207 890 600
Website: www.nilfisk.fi

FRANCE

Nilfisk SAS
26 Avenue de la Baltique
Villebon sur Yvette
91978 Courtabouef Cedex
Tel.: (+33) 169 59 87 00
Website: www.nilfisk.fr

GERMANY

Nilfisk GmbH
Guido-Oberdorfer-Straße 2-10
89287 Bellenberg

Tel.: (+49) (0)7306/72-444
Website: www.nilfisk.de

GREECE

Nilfisk A.E.
Αναπαύσεως 29
Κορωπί Τ.Κ. 194 00
Tel.: (30) 210 9119 600
Website: www.nilfisk.gr

HOLLAND

Nilfisk B.V.
Versterkerstraat 5
1322 AN Almere
Tel.: (+31) 036 5460760
Website: www.nilfisk.nl

HONG KONG

Nilfisk Ltd.
2001 HK Worsted Mills
Industrial Building
31-39, Wo Tong Tsui St.
Kwai Chung, N.T.
Tel.: (+852) 2427 5951
Website: nilfisk.com

HUNGARY

Nilfisk Kft.
II. Rákóczi Ferenc út 10
2310 Szigetszentmiklós-Lakihegy
Tel.: (+36) 24 475 550
Website: www.nilfisk.hu

INDIA

Nilfisk India Limited
Pramukh Plaza, 'B' Wing, 4th floor, Unit No. 403
Cardinal Gracious Road, Chakala
Andheri (East) Mumbai 400 099
Tel.: (+91) 22 6118 8188
Website: www.nilfisk.in

IRELAND

Nilfisk
1 Stokes Place
St. Stephen's Green
Dublin 2
Tel.: (+35) 3 12 94 38 38
Website: www.nilfisk.ie

ITALY

Nilfisk SpA
Strada Comunale della Braglia, 18
26862 Guardamiglio (LO)
Tel.: (+39) (0) 377 414021
Website: www.nilfisk.it

JAPAN

Nilfisk Inc.
1-6-6 Kita-shinyokohama, Kouhoku-ku
Yokohama, 223-0059
Tel.: (+81) 45548 2571
Website: www.nilfisk.com

MALAYSIA

Nilfisk Sdn Bhd
Sd 33, Jalan KIP 10
Taman Perindustrian KIP
Sri Damansara
52200 Kuala Lumpur
Tel.: (60) 3603 627 43 120
Website: www.nilfisk.com

MEXICO

Nilfisk de Mexico, S. de R.L. de C.V.
Pirineos #515 Int.
60-70 Microparque
Industrial WSantiago
76120 Queretaro
Tel.: (+52) (442) 427 77 00
Website: www.nilfisk.com

NEW ZEALAND

Nilfisk Limited
Danish House
6 Rockridge Avenue
Penrose, Auckland 1061
Tel.: (+64) 9526 3890
Website: www.nilfisk.com.au

NORWAY

Nilfisk AS
Bjørnerudveien 24
1266 Oslo
Tel.: (+47) 22 75 17 80
Website: www.nilfisk.no

PERU

Nilfisk S.A.C.
Calle Boulevard 162, Of. 703, Lima 33- Perú
Lima
Tel.: (511) 435-6840
Website: www.nilfisk.com

POLAND

Nilfisk Sp. Z.O.O.
Millenium Logistic Park
ul. 3 Maja 8, Bud. B4
05-800 Pruszków
Tel.: (+48) 22 738 3750
Website: www.nilfisk.pl

PORTUGAL

Nilfisk Lda.
Sintra Business Park
Zona Industrial Da Abrunheira
Edifício 1, 1º A

P2710-089 Sintra
Tel.: (+351) 21 911 2670
Website: www.nilfisk.pt

RUSSIA

Nilfisk LLC
Vyatskaya str. 27, bld. 7/1st
127015 Moscow
Tel.: (+7) 495 783 9602
Website: www.nilfisk.ru

SINGAPORE

Den-Sin
22 Tuas Avenue 2
639453 Singapore
Tel.: (+65) 6268 1006
Website: www.densin.com

SLOVAKIA

Nilfisk s.r.o.
Bancikovej 1/A
SK-821 03 Bratislava
Tel.: (+421) 910 222 928
Website: www.nilfisk.sk

SOUTH AFRICA

WAP South Africa
12 Newton Street
Spartan 1630
Tel.: (+27) 11 975 7060
Website: www.wap.com.za

SOUTH KOREA

Nilfisk Korea
3F Duksoo B/D, 317-15
Sungsoo-Dong 2Ga
Sungdong-Gu, Seoul
Tel.: (+82) 2497 8636
Website: www.nilfisk.co.kr

SPAIN

Nilfisk S.A.
Torre d'Ara,
Passeig del Rengle, 5 Plta. 10ª
08302 Mataró
Tel.: (34) 93 741 2400
Website: www.nilfisk.es

SWEDEN

Nilfisk AB
Taljegårdsgatan 4
431 53 Möndal
Tel.: (+46) 31 706 73 00
Website: www.nilfisk.se

SWITZERLAND

Nilfisk AG
Ringstrasse 19
Kircheberg/Industri Stelz
9500 Wil
Tel.: (+41) 71 92 38 444
Website: www.nilfisk.ch

TAIWAN

Nilfisk Ltd
Taiwan Branch (H.K)
No. 5, Wan Fang Road
Taipei
Tel.: (+88) 6227 00 22 68
Website: www.nilfisk.tw

THAILAND

Nilfisk Co. Ltd.
89 Soi Chokechai-Ruammitr
Viphavadee-Rangsit Road
Ladyao, Jatuchak, Bangkok 10900
Tel.: (+66) 2275 5630
Website: www.nilfisk.co.th

TURKEY

Nilfisk A.S.
Serifali Mh. Bayraktar Bulv. Sehit Sk. No:7
Umraniye, 34775 Istanbul
Tel.: +90 216 466 94 94
Website: www.nilfisk.com.tr

UNITED ARAB EMIRATES

Nilfisk Middle East Branch
SAIF-Zone
P.O. Box 122298
Sharjah
Tel.: (+971) (0) 655-78813
Website: www.nilfisk.com

UNITED KINGDOM

Nilfisk Ltd.
Nilfisk House, Bowerbank Way
Gilwilly Industrial Estate, Penrith
Cumbria CA11 9BQ
Tel.: (+44) (0) 1768 868995
Website: www.nilfisk.co.uk

UNITED STATES

Nilfisk Inc.
14600 21st Avenue North
Plymouth, MN-55447
Tel.: (+1) 800-989-2235
Website: www.nilfisk.com

VIETNAM

Nilfisk Vietnam
No. 51 Doc Ngu Str.
P. Vinh Phuc, Q.Ba Dinh
Hanoi
Tel.: (+84) 761 5642
Website: www.nilfisk.com